



D-305780

English

PB-101 PG2 / PB-102 PG2

Wireless Panic Button



Visonic

User's Guide

1. INTRODUCTION

The PB-101 PG2 and PB-102 PG2 are small PowerG pendants, designed for use with PowerMaster control panels and other PowerG receivers.

To activate transmission, press the pushbutton(s) at the center of the unit. When activated, the transmitter sends an alarm code, a LED indication that confirms successful or failed transmission, and (only in PB-102) a buzzer sound.

The PB-101/102 has several options for carrying or mounting it. The unit is supplied with a belt clip, a key chain, a lanyard necklace, and a holder which can be attached to the belt clip or mounted on a wall.

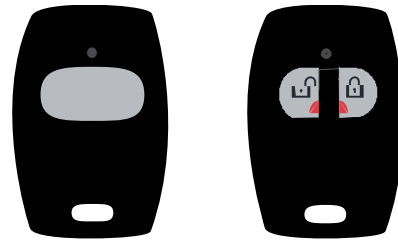

Figure 1. PB-101 and PB-102

2. OPERATION



CAUTION: This equipment shall be used in non-hazardous locations only.

The following functions are available:

Function	PB-101		PB-102	
Panic The signal will notify your central monitoring station of an emergency situation.		Press and hold the button down for 2 – 7 seconds.		Press and hold both buttons down simultaneously for more than 3 seconds.
Arm Arm your system in the Away mode.	---	Not applicable		Press and hold this button for at least 1 second.
Disarm Disarm your system.	---	Not applicable		Press and hold this button for at least 1 second.

3. ASSEMBLY FOR PORTABILITY AND MOUNTING

This section describes how to attach the PB-101/102 to various portability options.



WARNING! Choking Hazard; Small parts; The pendant and belt clip are NOT for children under 3 years.

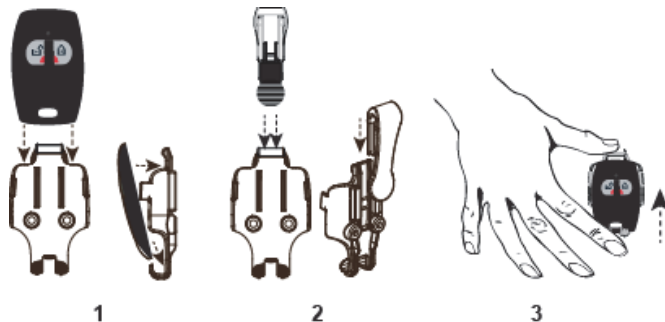

Figure 2 Attaching PB-101/102 to a Belt Clip

- Slide the PB-101/102 into the holder until you feel it snap securely inside.
- To attach the belt clip, slide it onto the rails on the rear of the holder.

- To remove the PB-101/102 from the wall-mounted holder or from the belt clip, press down the top of the holder and push the pendant up with your fingers.



Figure 3 Attaching PB-101/102 to a Key Chain



Figure 4 Attaching PB-101/102 to a Lanyard Necklace

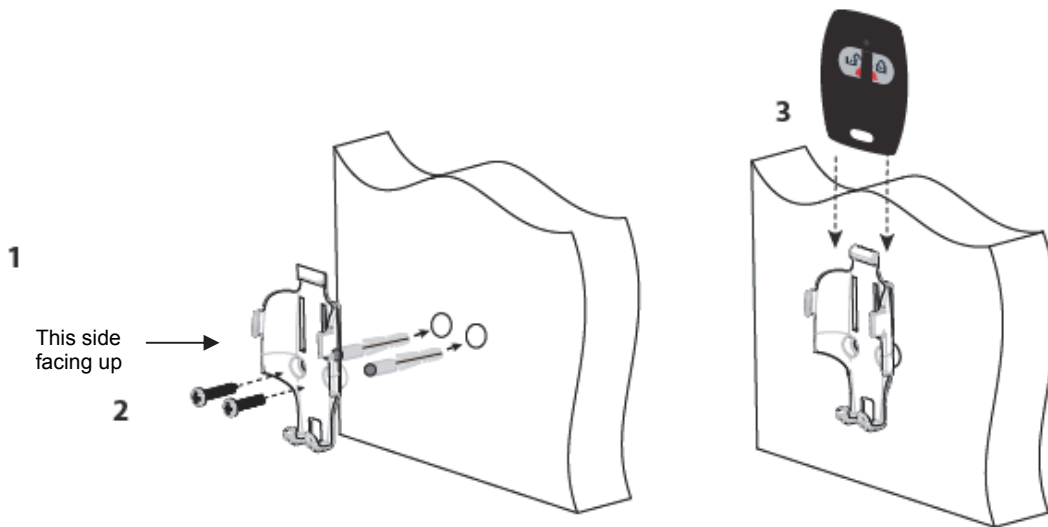



Figure 5 Attaching PB-101/102 to a Wall Mount

1. Using the two screws and plastic anchors included in the PB-101/102 box, align the holder facing up and secure the holder to the wall.
2. Slide the PB-101/102 into the holder until you feel it snap securely inside.
3. To remove the PB 101/102 from the holder, press down the top of the holder and push the pendant up with your fingers as illustrated in Figure 2.

4. ENROLLMENT AND CONFIGURATION OF PB-101/102

4.1 Enrollment

The Enrollment process “teaches” the system’s control panel the ID of the PB-101/102 and enables the PB-101/102 to communicate with the panel.

1. Enter the PowerMaster panel’s Installer menu and select “02:ZONES/DEVICES”.
2. Select “ADD NEW DEVICE” Option.
3. Stand near the PowerMaster panel. Press and hold the  button (for PB-101 PG2) or the left  button (for PB-102 PG2) until the yellow LED turns on, and then release the button. Ensure that the LED stays on for 2 seconds and then flashes for 10 seconds.

4.2 Configuring the Panic Button Parameters (for PowerG Version 18 systems only)

Enter the **DEVICE SETTINGS** menu and follow the configuration instructions for the PB-101 PG2 and PB-102 PG2 panic buttons as described below.

Option	Configuration Instructions
Functionality ¹	Define whether to use to Arm/Disarm or to operate the PGM. Optional settings: Arm/Disarm (default) and PGM ON/OFF.
Supervision	Define whether the control panel will monitor supervision messages sent by the panic button for a time period of 8 hours. Optional settings: Disabled (default) and Enabled.

5. TESTING AND MAINTENANCE

5.1 Testing a New Unit

Since the PB-101/102 is supplied with the battery already installed, the unit is practically ready to be tested.

IMPORTANT! Before testing, enroll the PB-101/102 in the target control panel as instructed in the panel’s programming instructions.

1. Stand 3 m (10 ft) away from the control panel and press the buttons. Verify that the transmit LED lights.
2. Make sure that the control panel responds as programmed and as stated in the panel’s programming instructions.

3. Operate the pendant from various locations within the area covered by the receiver to determine “dead” locations, where transmission is blocked by walls and large objects, or affected by structural materials.

Note: If dead/marginal zones are a problem, relocating the receiver may improve the performance.

¹ Applies to PB-102 PG2 only

5.2 Replacing the Battery

Replace the battery at least once every 5 years, or upon observing that the LED flickers when transmitting. The required battery is CR2032 Lithium 3V, manufactured by VARTA or another UL-recognized manufacturer, purchased from a Visonic-approved supplier.

NOTE: The polarity of the battery must be observed, as shown in Figure 7. Improper handling of lithium batteries may result in heat generation, explosion or fire, which may lead to personal injuries.

WARNING: Danger of explosion if batteries are installed incorrectly. Replace only with the same or equivalent type recommended by the manufacturer. Keep away from small children. If batteries are swallowed, promptly see a doctor. Do not try to recharge these batteries. Disposal of used batteries must be made in accordance with the waste recovery and recycling regulations in your area.

1. Insert a coin into the slot on the bottom center of the device and twist to separate the two sides.
2. Then, slide the coin to the corner of the device and twist again to remove the cover.

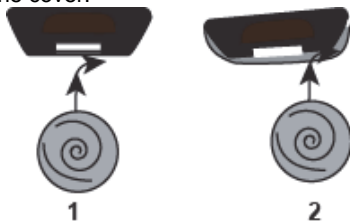

Figure 6. Opening the PB-101/102

5.3 Cleaning

The pendant may get dirty if touched with greasy fingers. Clean it only with a soft cloth or sponge moistened lightly with a mixture of water and mild detergent, and wipe it dry immediately.

Note: Make sure the elastic pad within the cover remains in place. Put it back in place if it falls off.

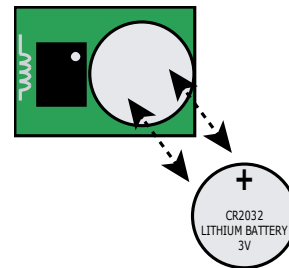

Figure 7. Replacing the Battery

3. Extract the old battery from its holder, and replace it with a recommended new battery. Ensure that the plus side of the battery faces up, attaining correct polarity.
4. Test the unit by momentarily pressing one of the transmit switches. The LED indicator should light.
5. Put the covers back on securely, verifying that it snaps shut.

The use of abrasives of any kind is strictly forbidden. Also never use solvents such as kerosene, acetone or thinner. Do not submerge this product in any liquid, in order to prevent damage to the electronic units.

6. PRODUCT LIMITATIONS

Visonic wireless systems are very reliable and are tested to high standards. However, due to their low transmitting power and limited range (required by FCC and other regulatory authorities), there are some limitations to be considered:

- A. Receivers may be blocked by radio signals occurring on or near their operating frequencies, regardless of the code selected.
- B. A receiver can only respond to one transmitted signal at a time.
- C. Wireless equipment should be tested regularly to determine whether there are sources of interference and to protect against faults.

Frequency Allocations for Wireless Devices in European (EU) Countries

433.92 MHz has no restriction in any EU member state.

7. COMPLIANCE WITH STANDARDS



The PB-101/102 PG2 complies with the following:

EN 300220, EN 301489 EN 50130-4, EN 50130-5, EN 61000-6-3, EN 60950-1, EN 50131-1, EN-50131-3 and EN-50131-6 Type C.

Certified by Applica Test and Certification

The PB-101 PG2 and PB-102 PG2 are compatible with the RTTE requirements - Directive 1999/5/EC of the European Parliament and of the Council of 9 March 1999.

USA: CFR 47 part 15 (FCC),

Canada: RSS 210,

The Power G peripheral devices have two-way communication functionality, providing additional benefits as described in the technical brochure. This functionality has not been tested to comply with the respective technical requirements and should therefore be considered outside the scope of the product's certification.

Security Grade

Complies with EN 50131-1, EN-50131-3 and EN-50131-6 Type C: this equipment can be applied in installed systems up to and including Security Grade 2.

Environmental Class

EN 50131-3 Class II

FCC Compliance Statement

The digital circuitry of this device has been tested and found to comply with the limits for a Class B digital device, pursuant to Part 15 of the FCC Rules. These limits are designed to provide reasonable protection against harmful interference in residential installations. This equipment generates, uses, and can radiate radio frequency energy and, if not installed and used in accordance with the instructions, may cause harmful interference to radio and television reception. However, there is no guarantee that interference will not occur in a particular installation. If this device does cause such interference, which can be verified by turning the device off and on, the user is encouraged to eliminate the interference by one or more of the following measures:

- Re-orient or re-locate the receiving antenna.
- Increase the distance between the device and the receiver.
- Connect the device to an outlet on a circuit different from the one which supplies power to the receiver.
- Consult the dealer or an experienced radio/TV technician

This equipment complies with FCC and IC RF radiation exposure limits set forth for an uncontrolled environment.

WARNING! Changes or modifications to this unit not expressly approved by the party responsible for compliance could void the user's authority to operate the equipment.

This device complies with FCC Rules Part 15 and with Industry Canada licence-exempt RSS standard(s). Operation is subject to two conditions: (1) This device may not cause harmful interference, and (2) this device must accept any interference that may be received or that may cause undesired operation.

Le présent appareil est conforme aux CNR d'Industrie Canada applicables aux appareils radio exempts de licence. L'exploitation est autorisée aux deux conditions suivantes : (1) l'appareil ne doit pas produire de brouillage, et (2) l'utilisateur de l'appareil doit accepter tout brouillage radioélectrique subi, même si le brouillage est susceptible d'en compromettre le fonctionnement.

APPENDIX: SPECIFICATIONS

<p>Frequency Band (MHz) Battery type Low Battery Threshold Battery Life Expectancy Operating Temperature Humidity Dimensions (LxWxD) Weight Weight (including battery)</p>	<p>Europe and rest of world: 433-434.72, 868-869.15 USA: 912-919.185 Varta 3V CR-2032 Lithium battery. 2.05 V up to 5 years -10° to 55°C (14° to 131°F) Average relative humidity (RH) ~ 75% non-condensing, max 95% 30 days/year 53 x 33 x 11 mm (2.1 x 1.3 x 0.43 in) 15 gm (0.5 oz) 20 gm (0.7 oz)</p>
---	---

	<p>W.E.E.E. Product Recycling Declaration For information regarding the recycling of this product you must contact the company from which you originally purchased it. If you are discarding this product and not returning it for repair then you must ensure that it is returned as identified by your supplier. <u>This product is not to be thrown away with everyday waste.</u> Directive 2002/96/EC Waste Electrical and Electronic Equipment. When this product is out of use, please remove all batteries and dispose of them separately. Bring electrical appliances to the local collecting points for waste electrical and electronic equipment. Batteries are harmful to health and the environment. Please help to protect the environment from health risks.</p>
--	--

<p>WARRANTY Visonic (the "Vendor") warrants this product only (the "Product") to the original purchaser only (the "Purchaser") against defective workmanship and materials under normal use of the Product for a period of twelve (12) months from the date of shipment by the Vendor. This Warranty is absolutely conditional upon the Product having been properly installed, maintained and operated under conditions of normal use in accordance with the Vendors recommended installation and operation instructions. Products which have become defective for any other reason, according to the Vendors discretion, such as improper installation, failure to follow recommended installation and operational instructions, neglect, willful damage, misuse or vandalism, accidental damage, alteration or tampering, or repair by anyone other than the vendor, are not covered by this Warranty. The Vendor does not represent that this Product may not be compromised and/or circumvented or that the Product will prevent any death and/or personal injury and/or damage to property resulting from burglary, robbery, fire or otherwise, or that the Product will in all cases provide adequate warning or protection. The Product, properly installed and maintained, only reduces the risk of such events without warning and it is not a guarantee or insurance that such events will not occur. THIS WARRANTY IS EXCLUSIVE AND EXPRESSLY IN LIEU OF ALL OTHER WARRANTIES, OBLIGATIONS OR LIABILITIES, WHETHER WRITTEN, ORAL, EXPRESS OR IMPLIED, INCLUDING ANY WARRANTY OF MERCHANTABILITY OR FITNESS FOR A PARTICULAR PURPOSE, OR OTHERWISE. IN NO CASE SHALL THE VENDOR BE LIABLE TO ANYONE FOR ANY CONSEQUENTIAL OR INCIDENTAL DAMAGES FOR BREACH OF THIS WARRANTY OR ANY OTHER WARRANTIES WHATSOEVER, AS AFORESAID. THE VENDOR SHALL IN NO EVENT BE LIABLE FOR ANY SPECIAL, INDIRECT, INCIDENTAL, CONSEQUENTIAL OR PUNITIVE DAMAGES OR FOR LOSS, DAMAGE, OR EXPENSE, INCLUDING LOSS OF USE, PROFITS, REVENUE, OR GOODWILL, DIRECTLY OR INDIRECTLY ARISING FROM PURCHASER'S USE OR INABILITY TO USE THE PRODUCT, OR FOR LOSS OR DESTRUCTION OF OTHER PROPERTY OR FROM ANY OTHER CAUSE, EVEN IF VENDOR HAS BEEN ADVISED OF THE POSSIBILITY OF SUCH DAMAGE. THE VENDOR SHALL HAVE NO LIABILITY FOR ANY DEATH, PERSONAL AND/OR BODILY INJURY AND/OR DAMAGE TO PROPERTY OR OTHER LOSS WHETHER DIRECT, INDIRECT, INCIDENTAL, CONSEQUENTIAL OR OTHERWISE, BASED ON A CLAIM THAT THE PRODUCT FAILED TO FUNCTION.</p>	<p>However, if the Vendor is held liable, whether directly or indirectly, for any loss or damage arising under this limited warranty, THE VENDOR'S MAXIMUM LIABILITY (IF ANY) SHALL NOT IN ANY CASE EXCEED THE PURCHASE PRICE OF THE PRODUCT, which shall be fixed as liquidated damages and not as a penalty, and shall be the complete and exclusive remedy against the Vendor. When accepting the delivery of the Product, the Purchaser agrees to the said conditions of sale and warranty and he recognizes having been informed of. Some jurisdictions do not allow the exclusion or limitation of incidental or consequential damages, so these limitations may not apply under certain circumstances. The Vendor shall be under no liability whatsoever arising out of the corruption and/or malfunctioning of any telecommunication or electronic equipment or any programs. The Vendors obligations under this Warranty are limited solely to repair and/or replace at the Vendor's discretion any Product or part thereof that may prove defective. Any repair and/or replacement shall not extend the original Warranty period. The Vendor shall not be responsible for dismantling and/or reinstallation costs. To exercise this Warranty the Product must be returned to the Vendor freight pre-paid and insured. All freight and insurance costs are the responsibility of the Purchaser and are not included in this Warranty. This warranty shall not be modified, varied or extended, and the Vendor does not authorize any person to act on its behalf in the modification, variation or extension of this warranty. This warranty shall apply to the Product only. All products, accessories or attachments of others used in conjunction with the Product, including batteries, shall be covered solely by their own warranty, if any. The Vendor shall not be liable for any damage or loss whatsoever, whether directly, indirectly, incidentally, consequentially or otherwise, caused by the malfunction of the Product due to products, accessories, or attachments of others, including batteries, used in conjunction with the Products. This Warranty is exclusive to the original Purchaser and is not assignable. This Warranty is in addition to and does not affect your legal rights. Any provision in this warranty which is contrary to the Law in the state or country where the Product is supplied shall not apply. Warning: The user must follow the Vendor's installation and operational instructions including testing the Product and its whole system at least once a week and to take all necessary precautions for his/her safety and the protection of his/her property.</p>
---	---

Notice: Some jurisdictions require two-button pendants for use with monitored personal emergency response systems. The customer assumes all responsibility for the proper selection, installation, operation and maintenance of this product.



EMAIL: info@visonic.com
 INTERNET: www.visonic.com
 ©VISONIC LTD. 2014 PB-101/102 (UK) D-305780 (REV. 0, 1/15)

